

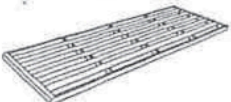

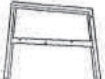

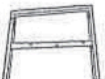







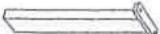

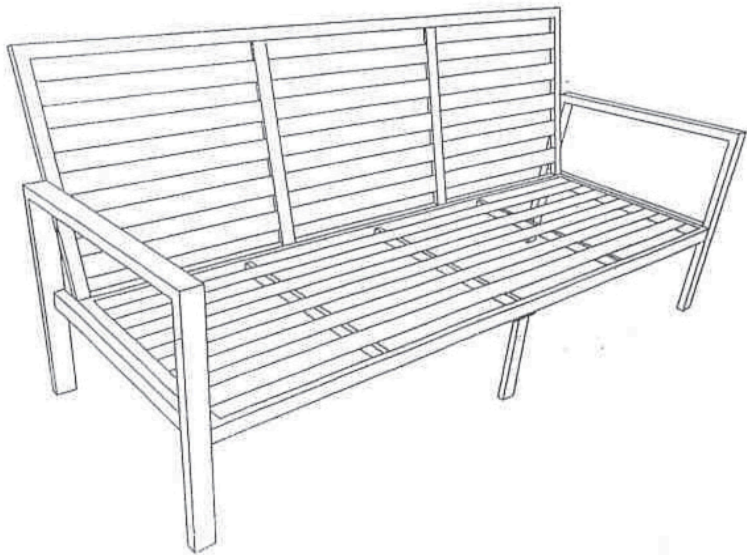
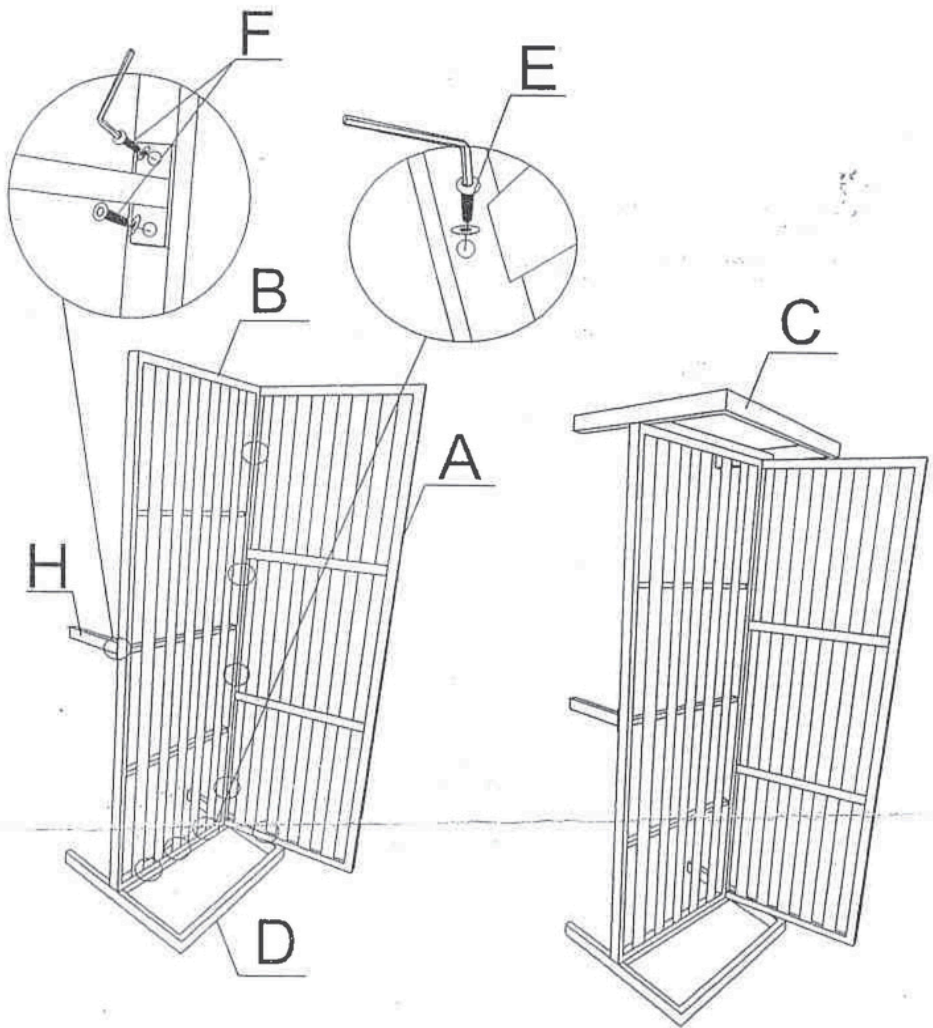
A 1x

B 1x

C 1x

D 1x

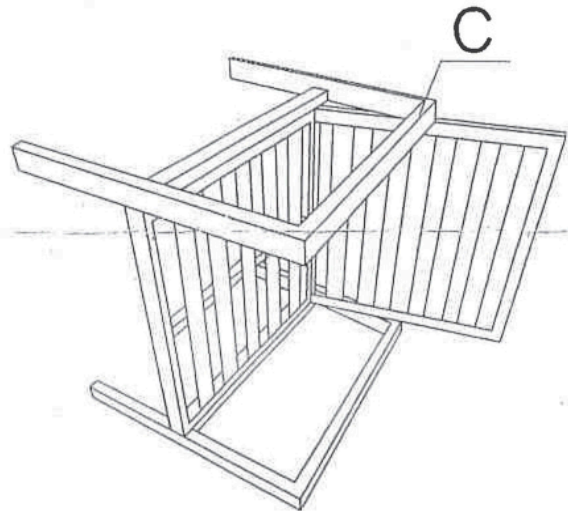
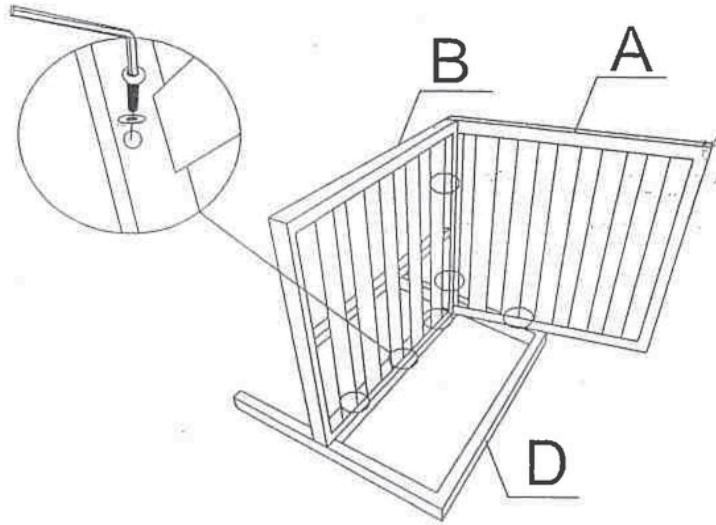
E M6*35 12x

F 14x

G 1x

H 1x

F M6*15 2x



A 1x

B 1x

C 1x

D 1x

E M6*35 12x

F 12 x

G 1x





A 1x



B 2x



C M6*35 6x



D 22x



E 1x



G M6*15 16x

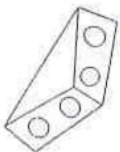

H 4x

