

DŮLEŽITÉ!

Před použitím a montáží si pečlivě přečtěte tento návod a uschovejte jej pro budoucí použití!

DÔLEŽITÉ!





Pred použitím a montážou si pozorne prečítajte tento návod a uschovajte ho pre budúce použitie! and assembly and keep for future reference!

WAŻNE!



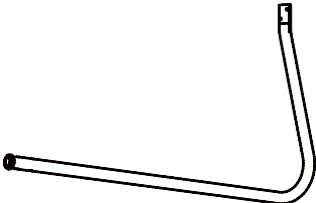
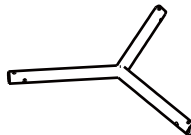
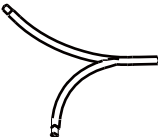

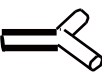
Przed rozpoczęciem użytkowania i instalacji należy uważnie przeczytać niniejszą instrukcję i zachować ją na przyszłość!

Rozměry montáže/Rozmery montáže/Wymiary montażowe: ca. 209 x 209 x 205 cm



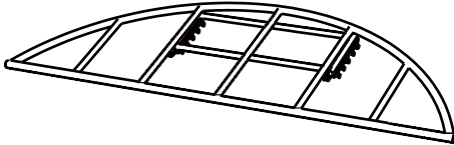
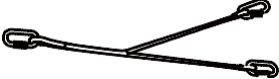

Seznam dílů / Zoznam dielov / Lista części:

A		3 x
B		1 x
C		3 x
D		3 x
E		3 x
F		1 x
G		6 x



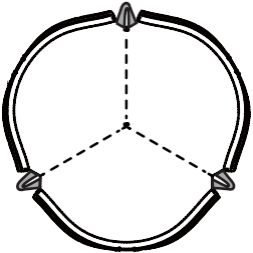
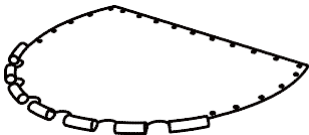
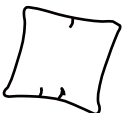



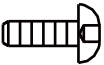
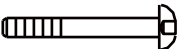

Seznam dílů / Zoznam dielov / Lista części:

H		1	X
I		1	X
J		1	X
K		1	X
L		1	X
M		1	X
N		3	X

Seznam dílů / Zoznam dielov / Lista części:

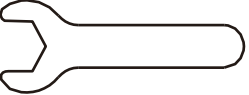
O		1	X
P		1	X
Q₁		2	X
Q₂		1	X
T₁	 M8×55	12	X
T₂	 M8×50	15	X
T₃	 M8×40	3	X

Seznam dílů / Zoznam dielov / Lista części:

T₄	 M8x20	6	x
T₅	 M6x60	3	x
U	 M8	18	x
R		2	x
S		9	x
V		1	x
W		2	x
Y₁		1	x
Y₂		1	x

!

Seznam dílů / Zoznam dielov / Lista części:

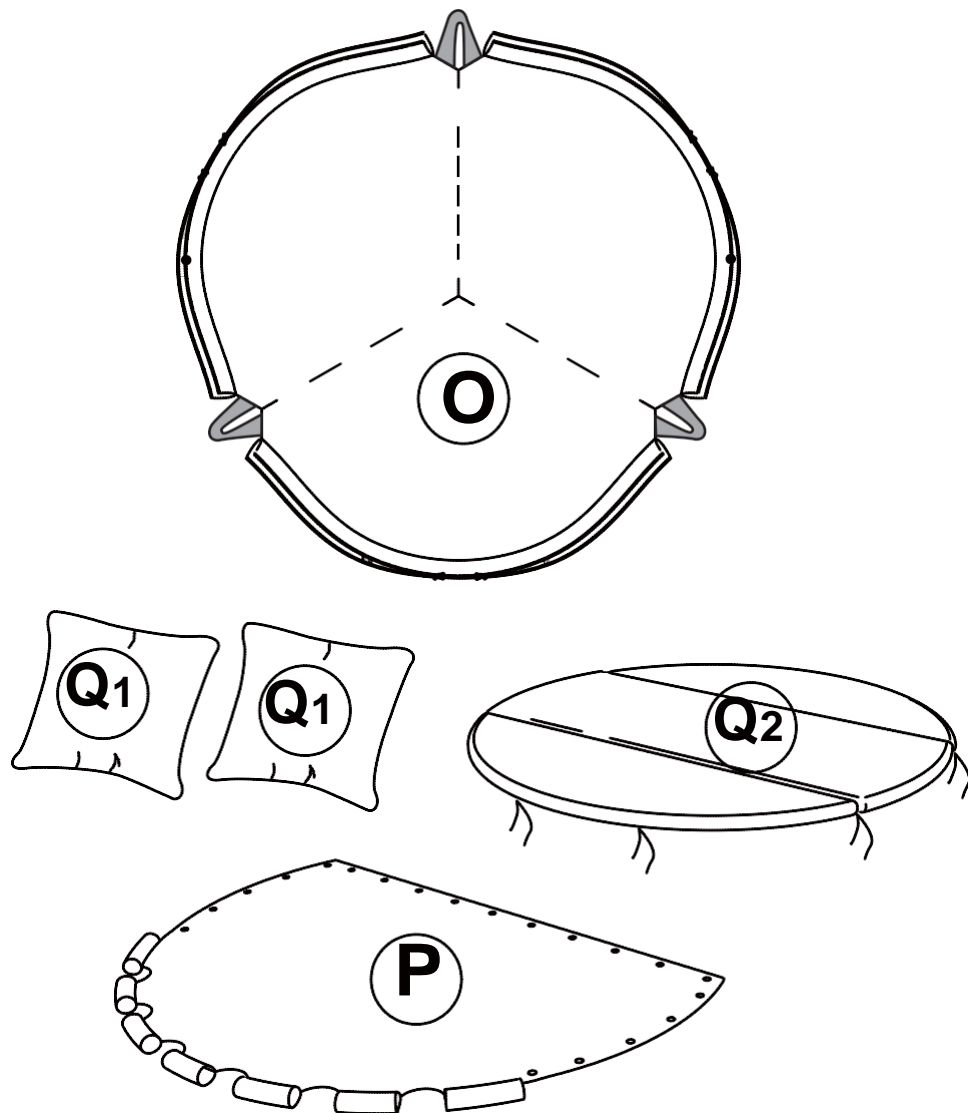

Seznam dílů / Zoznam dielov / Lista części:

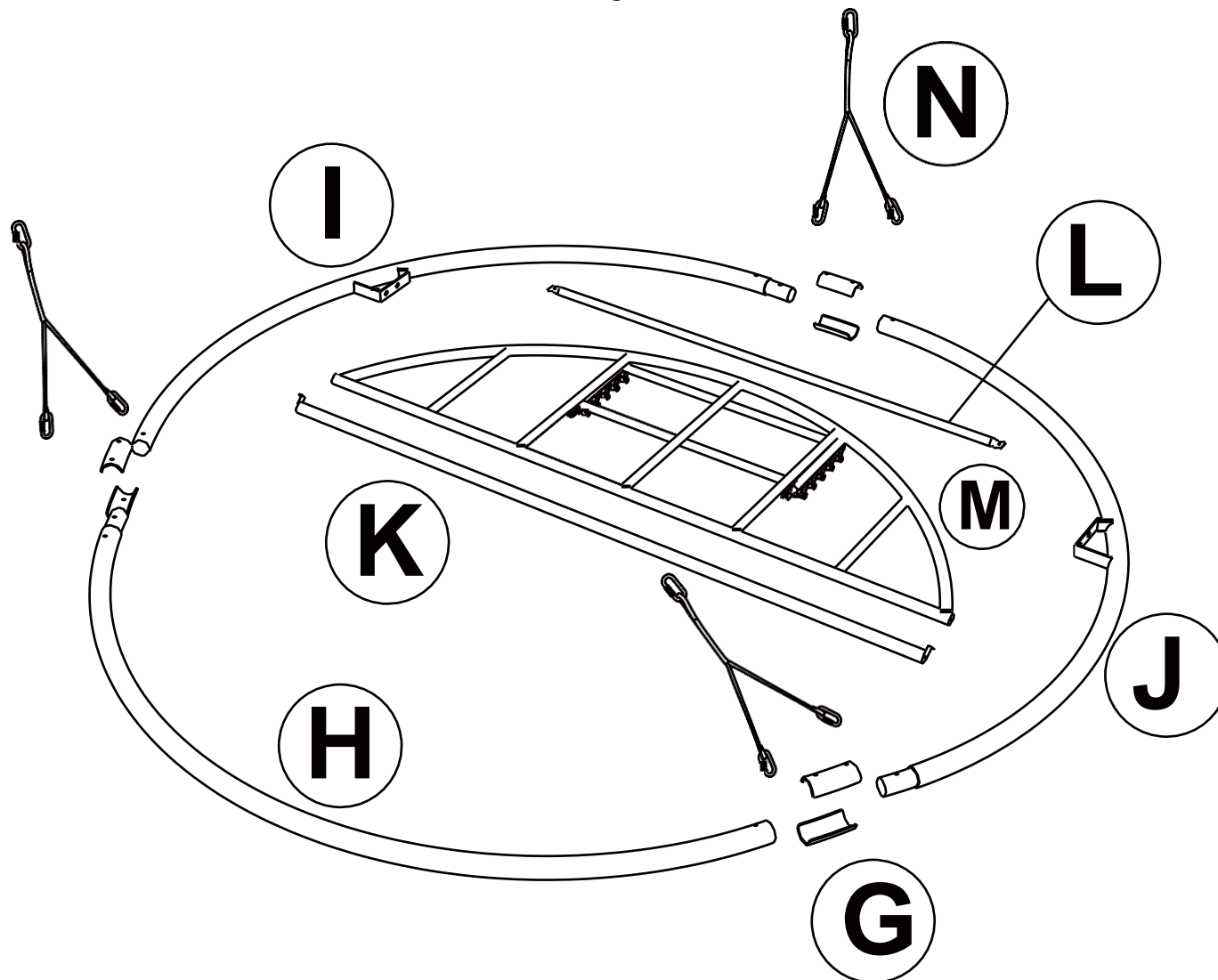

Seznam dílů / Zoznam dielov / Lista części:

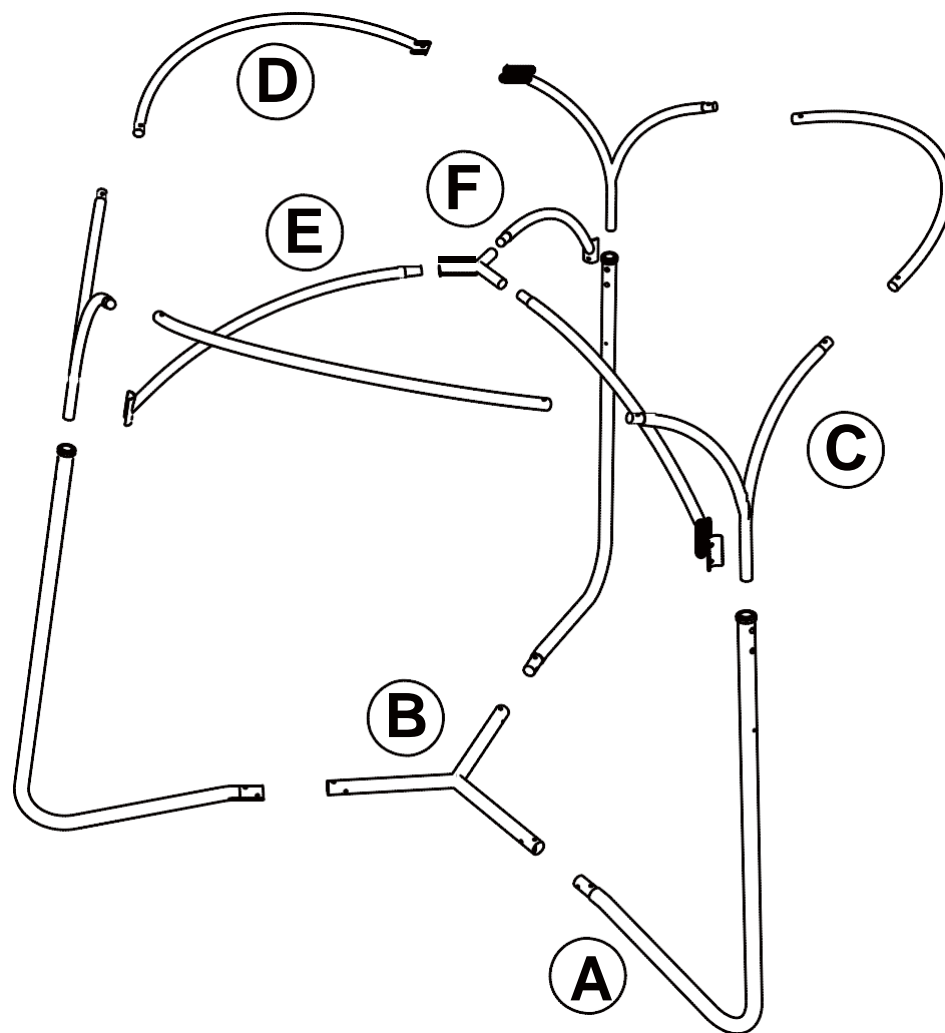

Montážní návod / Montažny návod / Instrukcje instalacji:

①

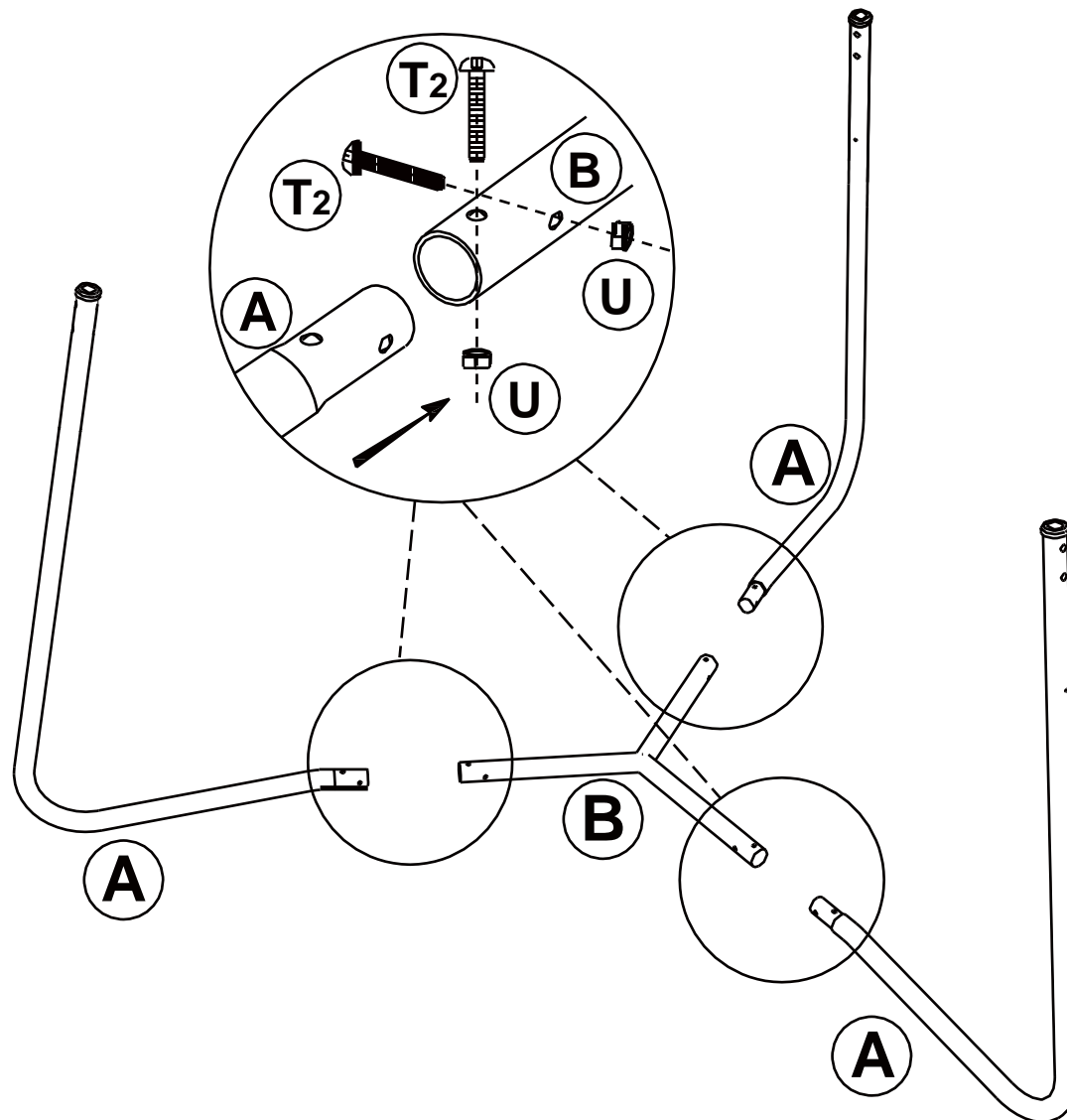

Šrouby zatím nedotahujte!
Skrutky zatiaľ nedotahujte!
Alle schroeven los aandraaien!

Montážní návod / Montažny návod / Instrukcje instalacji:

②

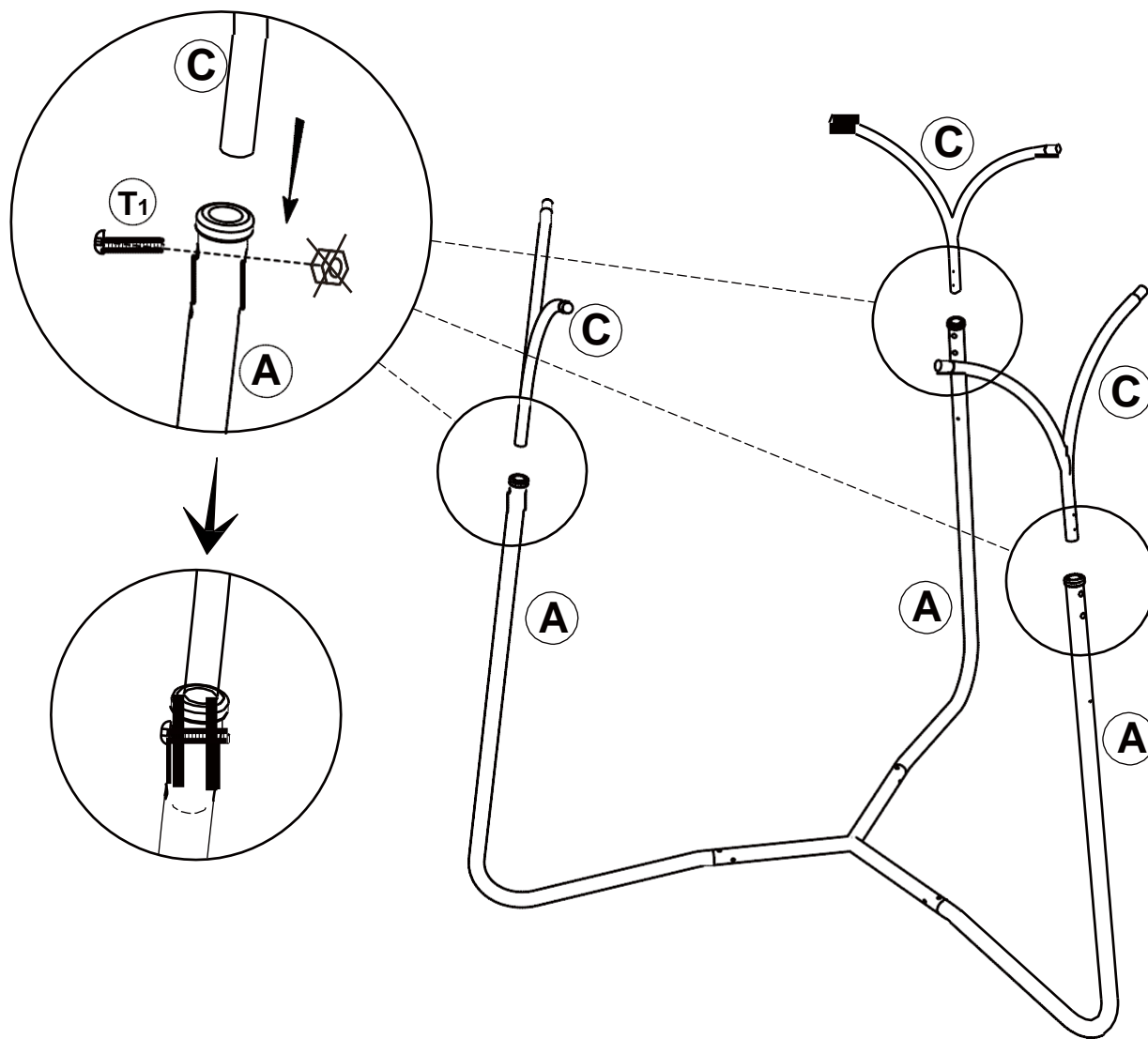

Šrouby zatím nedotahujte!
Skrutky zatiaľ nedoťahujte!
Alle schroeven los aandraaien!

Montážní návod / Montažny návod / Instrukcje instalacji:

③

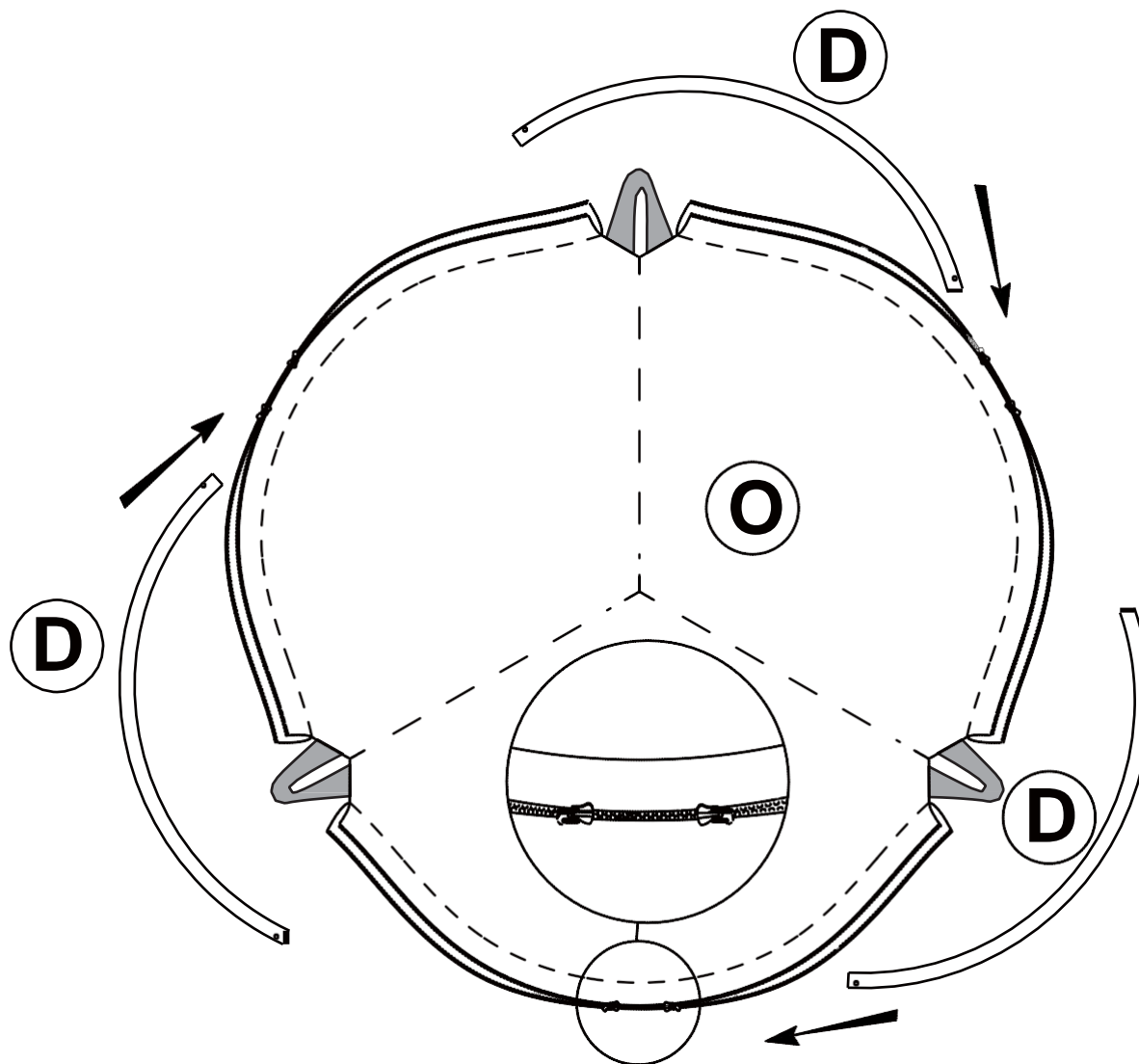

Šrouby zatím nedotahujte!
Skrutky zatiaľ nedotahujte!
Alle schroeven los aandraaien!

Montážní návod / Montažny návod / Instrukcje instalacji:

④

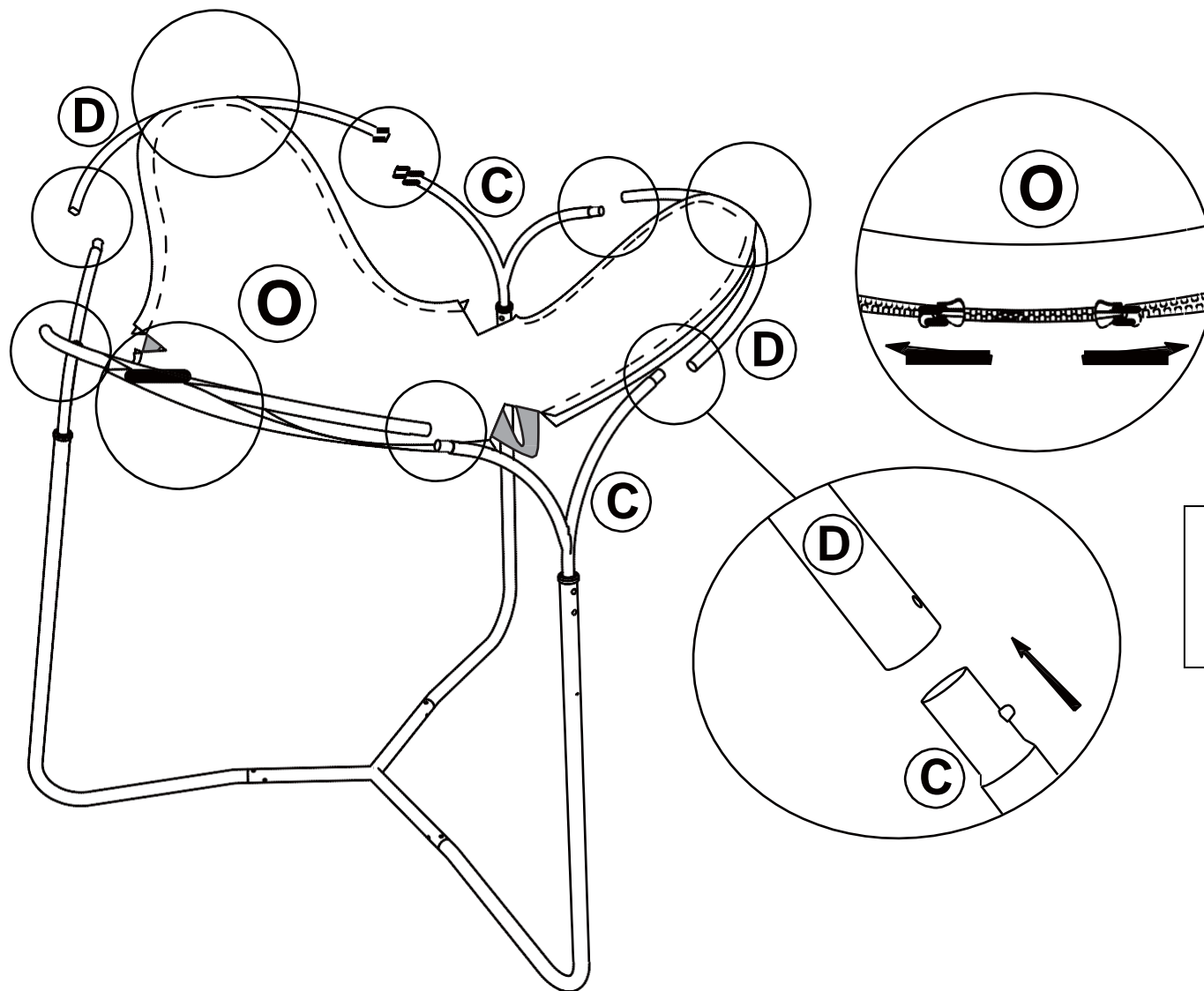

Šrouby zatím nedotahujte!
Skrutky zatiaľ nedotahujte!
Alle schroeven los aandraaien!

Montážní návod / Montažny návod / Instrukcje instalacji:

5

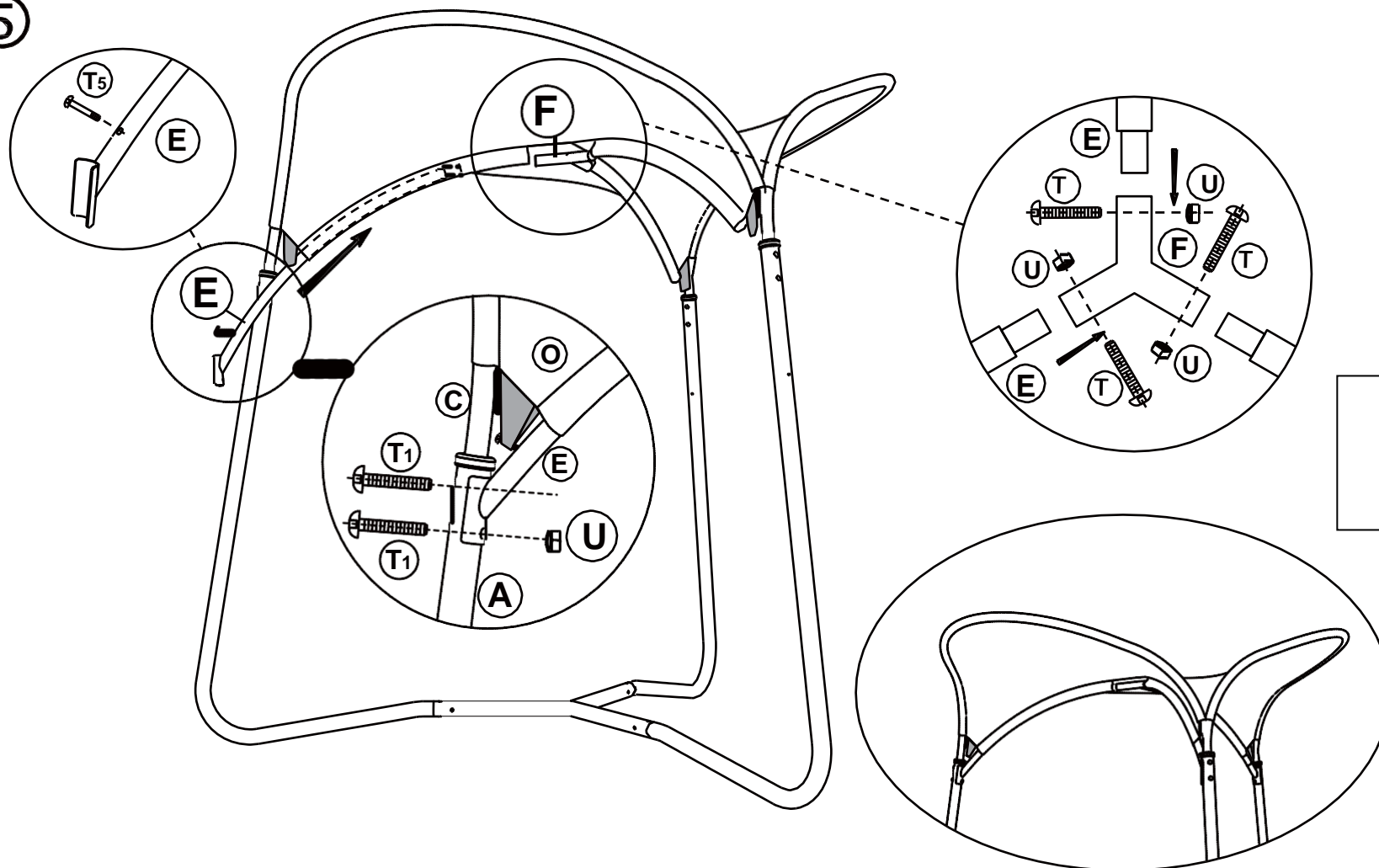

Šrouby zatím nedotahujte!
Skrutky zatiaľ nedotahujte!
Alle schroeven los aandraaien!

Montážní návod / Montažny návod / Instrukcje instalacji:

⑥

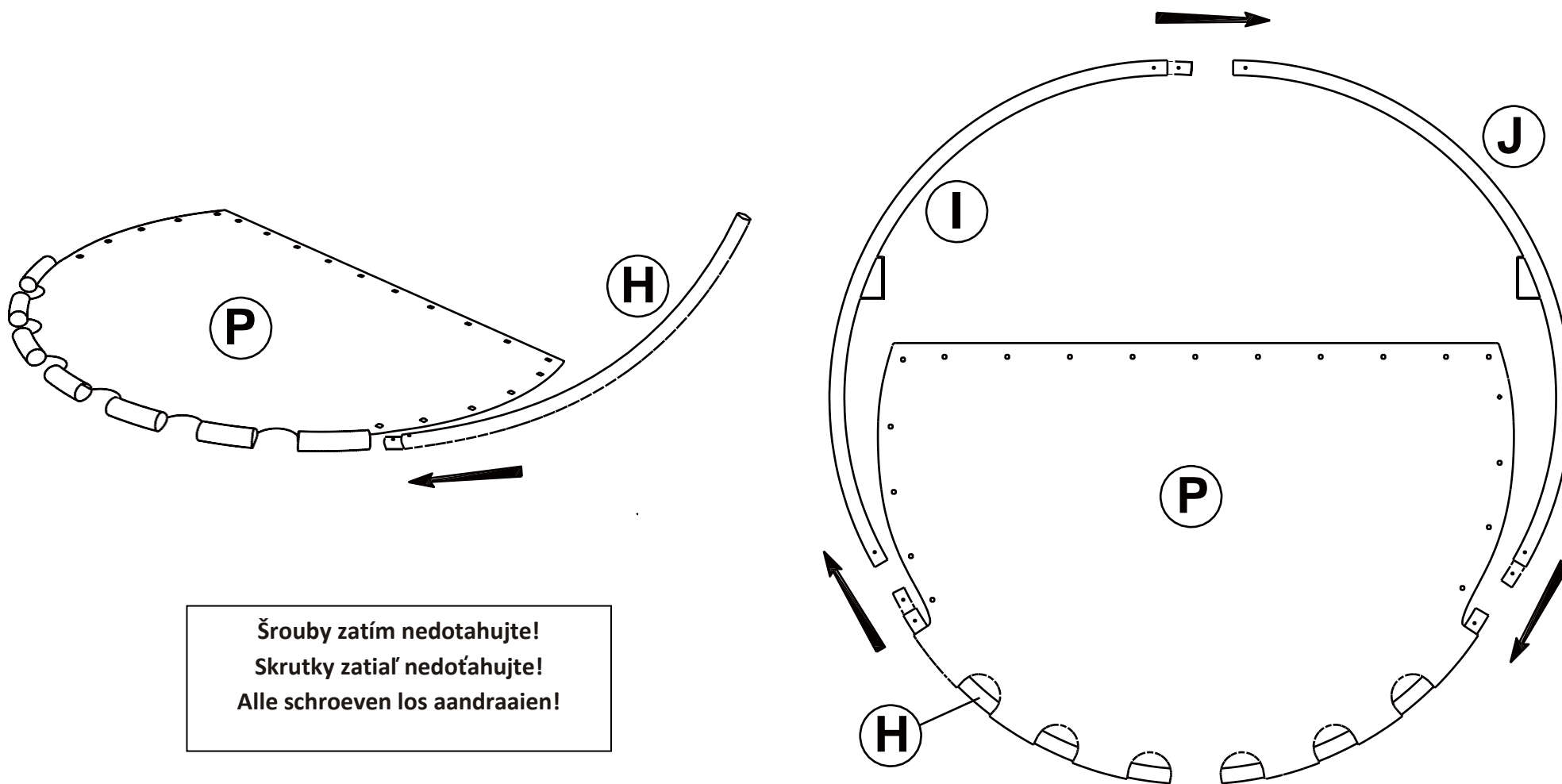

Montážní návod / Montažny návod / Instrukcje instalacji:

7

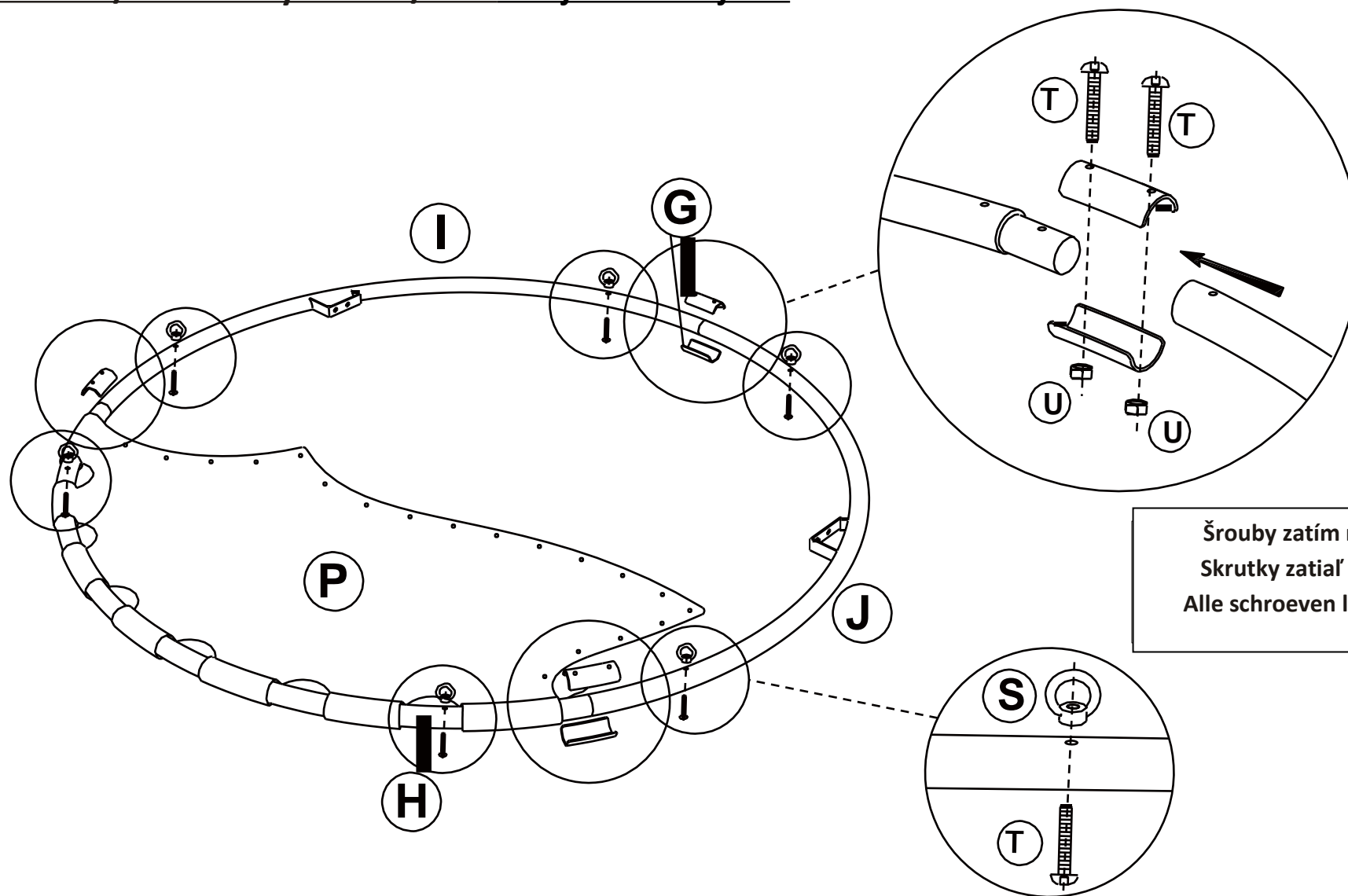

Montážní návod / Montažny návod / Instrukcje instalacji:

⑧

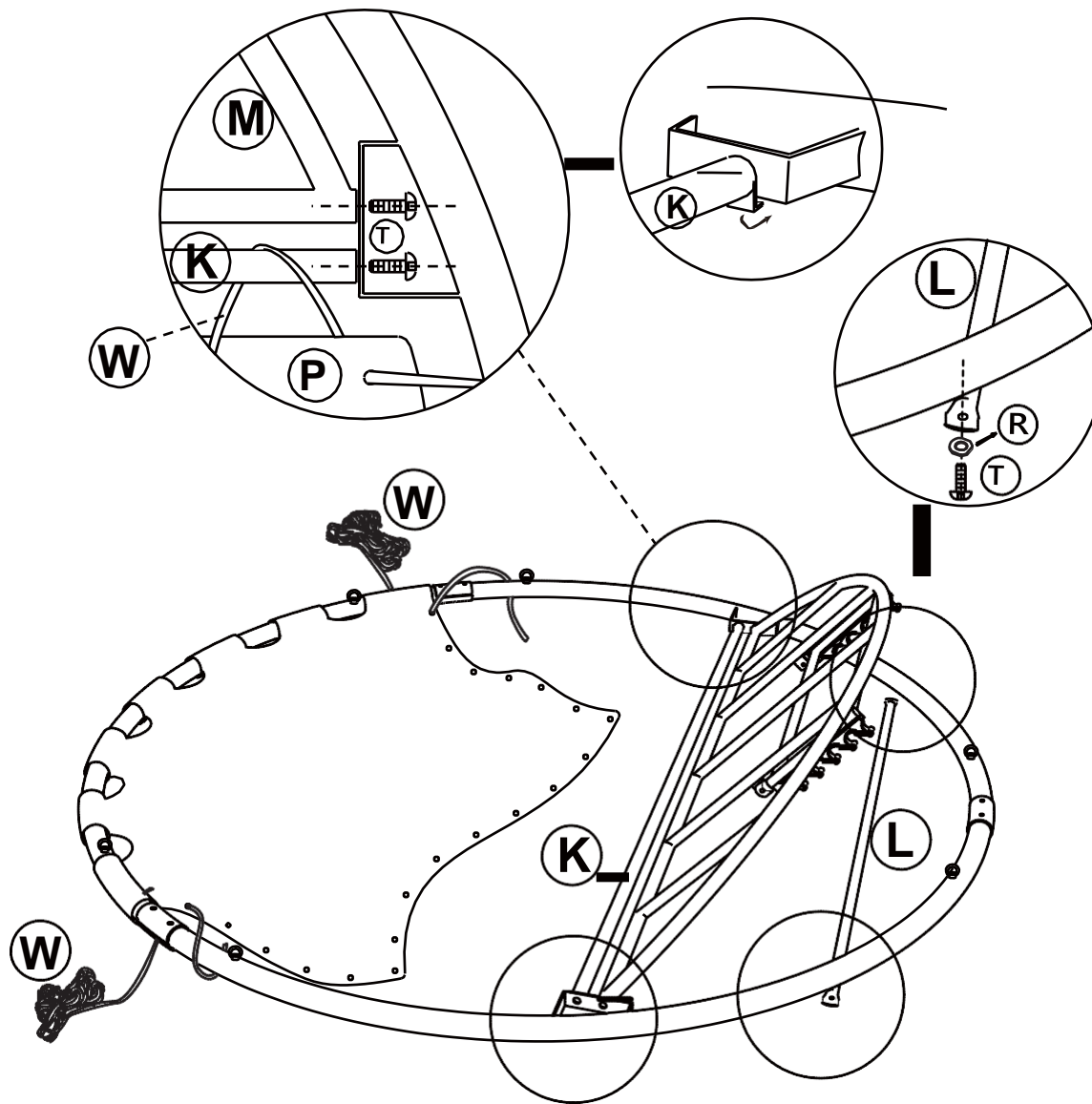

Šrouby zatím nedotahujte!
Skrutky zatiaľ nedotahujte!
Alle schroeven los aandraaien!

Montážní návod / Montažny návod / Instrukcje instalacji:

9

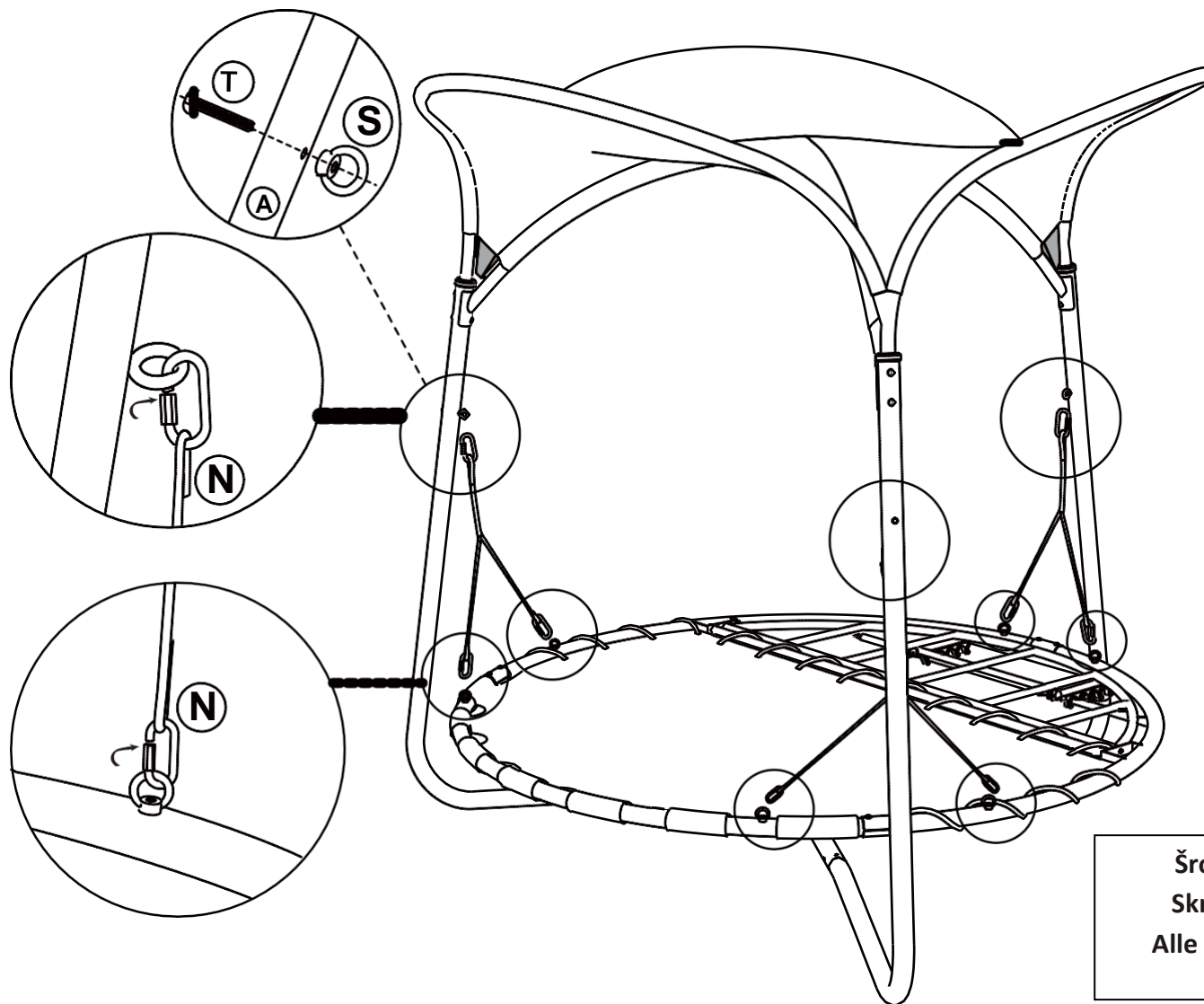

Šrouby zatím nedotahujte!
Skrutky zatiaľ nedotahujte!
Alle schroeven los aandraaien!

Montážní návod / Montažny návod / Instrukcje instalacji:

10

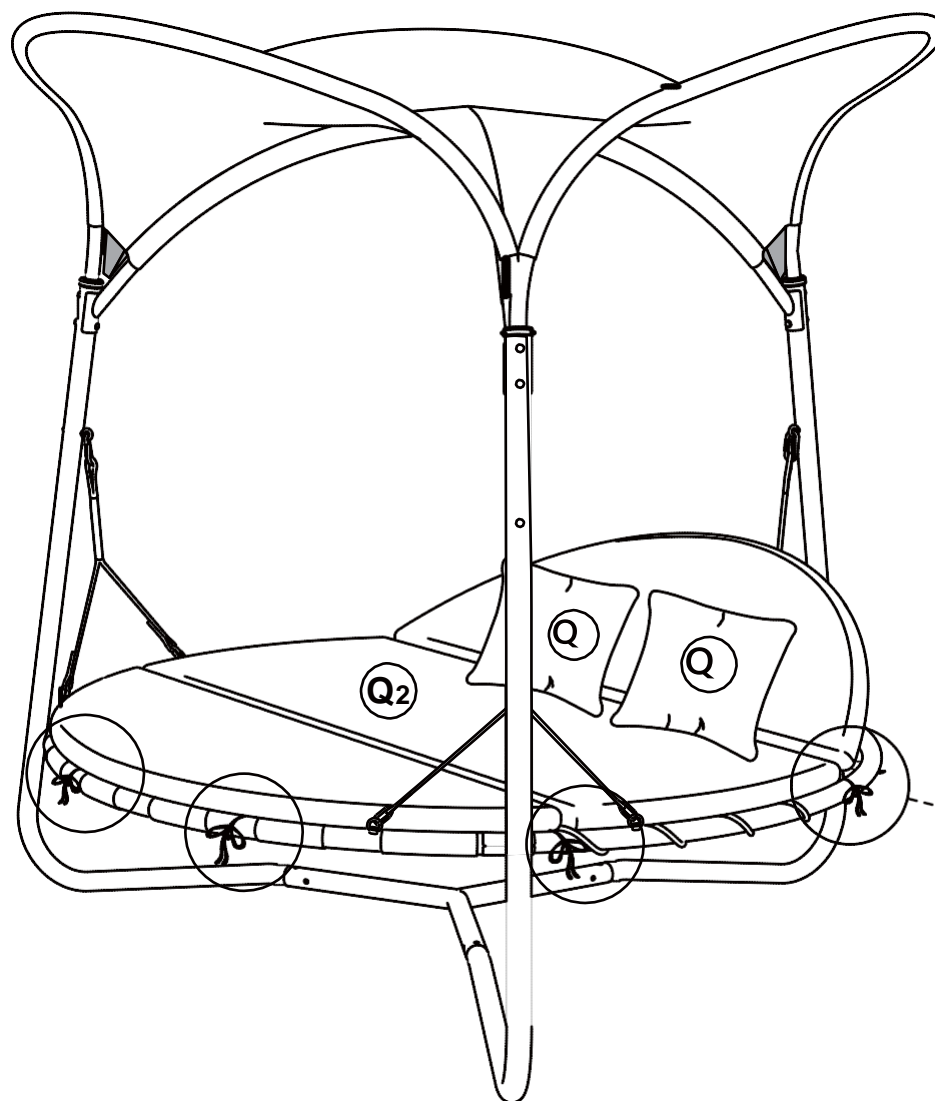

Šrouby zatím nedotahujte!
Skrutky zatiaľ nedotahujte!
Alle schroeven los aandraaien!

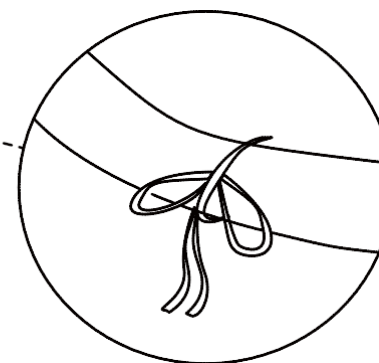

Mareike lehátko/houpačka závěsné



Montážní návod / Montažny návod / Instrukcje instalacji:

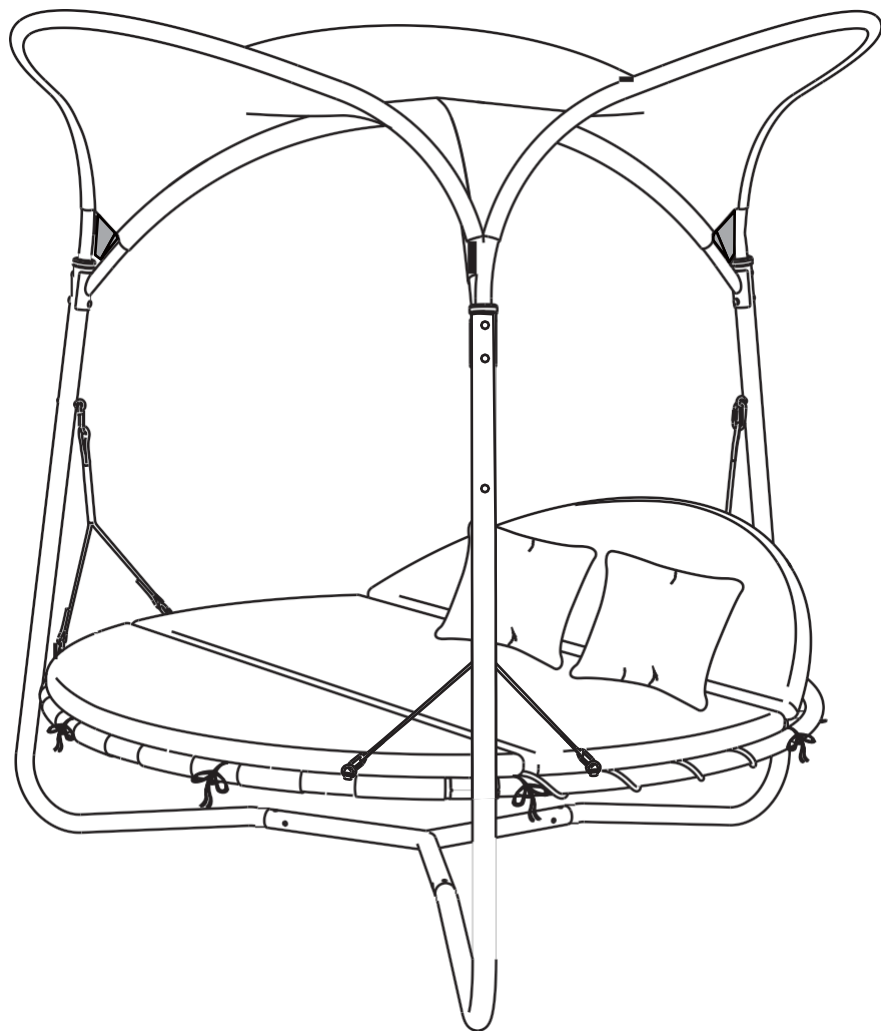

**Nyní pevně utáhněte šrouby! Šrouby pravidelně kontrolujte.
Teraz pevne utiahnite skrutky! Skrutky pravidelne kontrolujte.
Teraz mocno dokręć śruby! Regularnie sprawdzaj śruby.**

Mareike lehátko/houpačka závěsné

